

Registered / Registrato 30/06/2021

No 008595706-0003



**EUROPEAN UNION INTELLECTUAL
PROPERTY OFFICE
CERTIFICATE OF REGISTRATION**

This Certificate of Registration is hereby issued for the Registered Community Design identified below. The corresponding entries have been recorded in the Register of Community Designs.

**UFFICIO DELL'UNIONE EUROPEA PER
LA PROPRIETÀ INTELLETTUALE
CERTIFICATO DI
REGISTRAZIONE**

Il presente Certificato di Registrazione è emesso per il Disegno o Modello Comunitario registrato descritto di seguito. I dati corrispondenti sono stati iscritti nel Registro dei Disegni e Modelli Comunitari.

*The Executive Director / Il Direttore
esecutivo*

Christian Archambeau





- 21 008595706-0003
25 EN - IT
22 30/06/2021
15 30/06/2021
45 12/07/2021
11 008595706-0003
72 Ronny Gobbo
Ricardo Rodriguez
73 G.D. & C. S.r.l.
Via O. Bottecchia 6
I-33087 Pasiano di Pordenone PN
ITALIA
74 SOCIETÀ ITALIANA BREVETTI S.P.A.
Stradone San Fermo, 21/B
I-37121 Verona
ITALIA
51 06 - 03
54 **BG** - Маса за компютърни терминали
ES - Mesas para terminales informáticos
CS - Stoly pro počítačová zařízení
DA - Borde til computerterminaler
DE - Computertische
ET - Arvutilauad
EL - Τραπέζια για τερματικά ηλεκτρονικών υπολογιστών
EN - Tables for computer terminals
FR - Tables pour terminaux d'ordinateur
IT - Tavoli per terminali e di computer
LV - Datoru galdi
LT - Kompiuterių stalai
HR - Stolovi za računala
HU - Számítógépasztalok
MT - Mwejjed għat-terminali tal-kompjuter
NL - Computertafels
PL - Stoły do komputerów
PT - Mesas para terminais de computador
RO - Mese pentru computere
SK - Stoly na počítačové terminály
SL - Mize za računalniške terminale
FI - Tietokonepöydät
SV - Datorbord
30 -
55 -

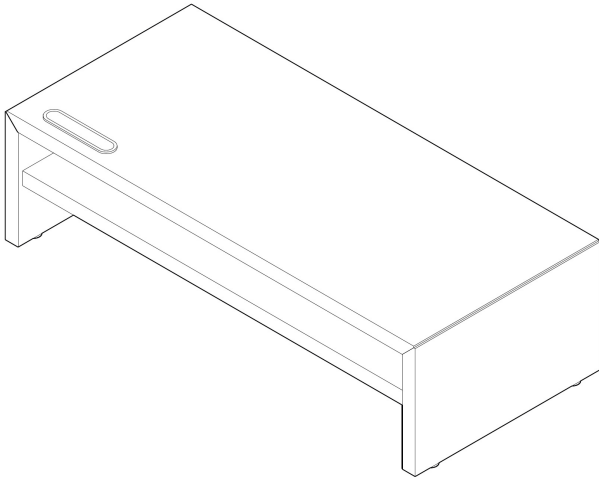

0003.1

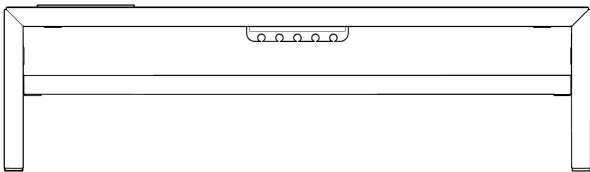

0003.2

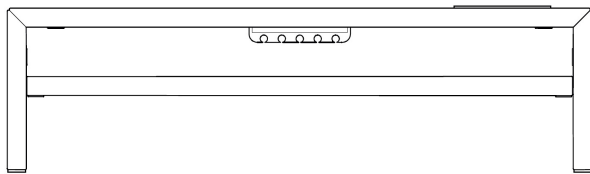

0003.3

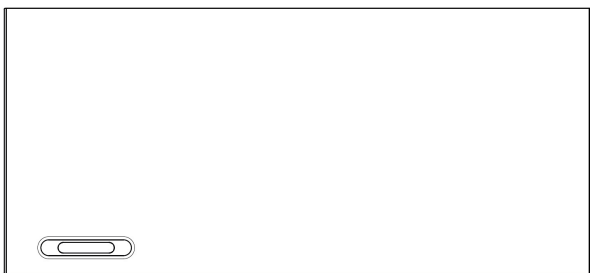

0003.4

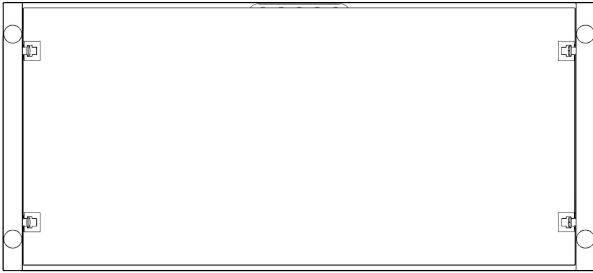

0003.5

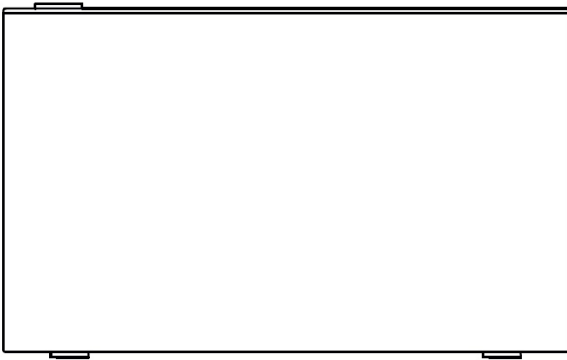

0003.6

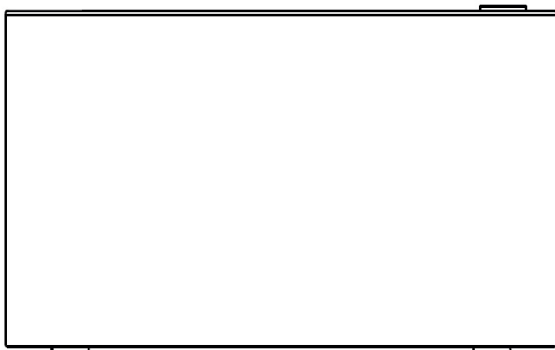

0003.7